



REFURBISHMENT

Sika[®] FerroGard[®]-903 Plus

THE UNIQUE MULTI-FUNCTIONAL SURFACE APPLIED CORROSION INHIBITOR FOR REINFORCED CONCRETE

BUILDING TRUST



CORROSION IN REINFORCED CONCRETE STRUCTURES

AGGRESSIVE INFLUENCES ON REINFORCED CONCRETE

In reinforced concrete the steel is normally protected against corrosion by the passivating alkalinity of the cement matrix. Due to the ingress of aggressive environmental influences the steel can corrode. Three conditions must exist for reinforcing steel to corrode:

- The passivation of the steel must have been destroyed by chlorides or by carbonation
- The presence of moisture as an electrolyte
- The presence of oxygen

Carbonation

Carbon dioxide ingress causes carbonation of the cement matrix progressively reducing the passivating alkaline protection of the steel reinforcement to a level where corrosion can occur.

Chloride attack

Chloride ions from deicing salts or marine exposure are carried into the concrete in solution in water. At the steel surface, even in alkaline concrete, they attack and break down the passivating layer and then accelerate the steel corrosion process.

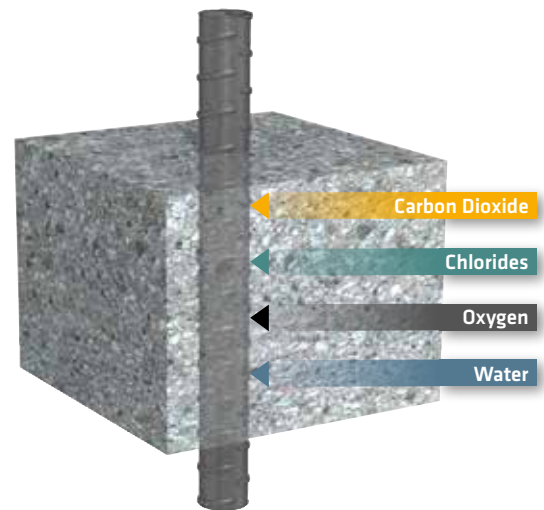

THE EFFECT OF THE AGGRESSIVE INFLUENCES

Chlorides/Carbonation

As soon as sufficient chloride ions (from deicing salts or marine exposure) or the carbonation front have reached the steel surface, the passive layer is destroyed and corrosion accelerates.

Contact with water (moisture)

The original neutral iron will receive a negative charge as the positively loaded ions have the tendency to dissolve. The water film around the metal turns positive.

Contact with oxygen

The oxygen takes on the negative charge of the iron ions which have gone into solution. The result is iron hydroxide, the first stage of rust.

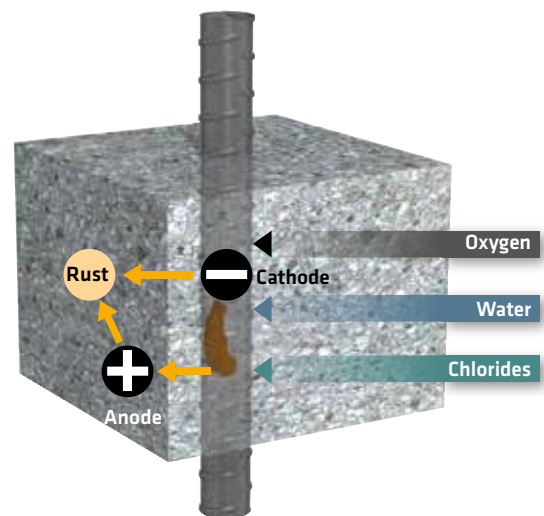

EXISTING CONDITIONS AND AGGRESSIVE INFLUENCES ON THE STRUCTURE

NEW CONSTRUCTION

New building/new concrete e.g. high quality architectural concrete without protective coating.
The steel reinforcement is protected by the passivating alkalinity of the cement matrix, pH 12.5 to 13.5.
With the ingress of aggressive environmental influences, steel reinforcement can corrode. The concrete will be carbonated or passivation broken down by penetrating chlorides.

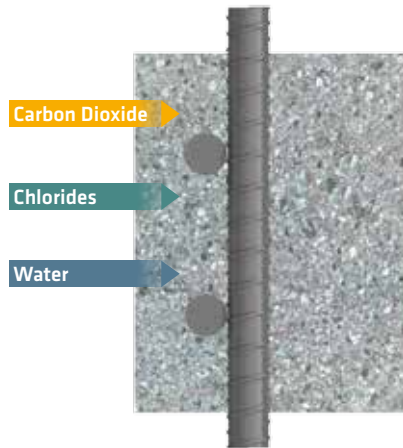

OBJECTIVES AND REQUIREMENTS

- Increasing service life of structure
- Preservation of architectural aspects
- Preserving protection to reinforcement
- No protective coatings

WELL ADVANCED CORROSION RISK BUT NO VISIBLE CORROSION DAMAGE

Concrete façade or civil engineering structure without protective coating.

- Steel reinforcement in a carbonated environment
- Perhaps light corrosion already exists
- No visible corrosion damage

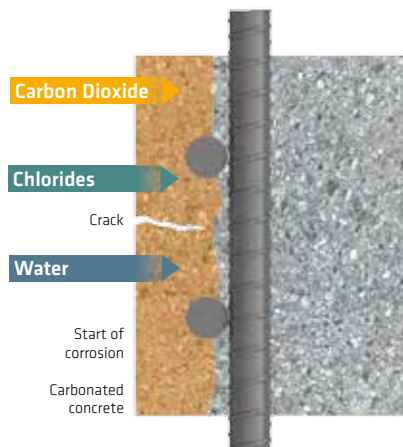

OBJECTIVES AND REQUIREMENTS

- Prevention maintenance
- Protection against possible concrete damage
- Re-passivation of steel
- Long-term protection against further environmental influences (carbonation, deicing salt, etc.)

VISIBLE CORROSION DAMAGE, CONCRETE REPAIR NECESSARY

Concrete surface (façade or civil engineering structure) without coating but with visible corrosion damage, e.g. spalling concrete, cracks, etc., concrete repair is necessary.

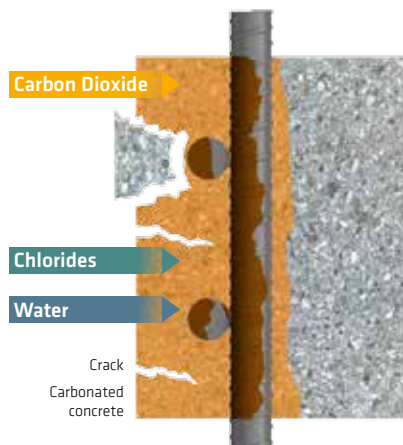

OBJECTIVES AND REQUIREMENTS

- Active maintenance
- Repair of damaged concrete surfaces only
- Structurally sound carbonated/chloride contaminated concrete remains
- Controlled concrete breakout
- Re-passivation of steel
- Protection against the development of latent damage
- Prevent the possibility of incipient anode corrosion
- Long-term protection against further Environmental influences

CORROSION MANAGEMENT WITH Sika® FerroGard® TECHNOLOGY

DESCRIPTION

Sika® FerroGard®-903 Plus is:

- a unique blend of non toxic, organic corrosion inhibitor based on amino alcohol and salts of amino alcohol technology, designed for use as an impregnation on hardened reinforced concrete.
- a multifunctional inhibitor which controls the cathodic and anodic reactions. This dual action effect significantly retards both the onset and the rate of corrosion and increases the time to future maintenance.
- normally applied as part of a corrosion management strategy. It is compatible and a component of all the Sika concrete repair and protection systems.

PERFORMANCE AND DURABILITY

Sika® FerroGard®-903 Plus penetrates the concrete and forms an adsorbed protective film on the surface of the steel reinforcement.

The protective adsorbed film of Sika® FerroGard®-903 Plus reduces the rate of corrosion in carbonated and chloride contaminated concrete. Many studies have been carried out on corrosion inhibitor technology around the world.

Assessment of the technology has been investigated by Mott MacDonald and the Monarch University.

A more detailed investigation into the behaviour in carbonated concrete was done by the University of Cape Town and additionally with chloride contaminated concrete by the BRE, UK and the European project SAMARIS.



THE PERFORMANCE OF Sika® FERROGARD®-903 PLUS

Sika® FerroGard®-903 Plus forms an adsorbed protective film on the reinforcement. The process of forming this protective film takes place even in carbonated concrete and even with the presence of chlorides in the concrete.

Delay of the corrosion process

- The dissolution of the iron in contact with water will be reduced thanks to this passivating protective film
- This film is also a barrier to the reduction of oxygen which will be prevented

APPLICATION

Sika® FerroGard®-903 Plus is applied as an impregnation by spray, roller or brush onto the surface of the concrete. The corrosion inhibitor penetrates into the concrete and protects the reinforcement by forming a protective film on the steel surface. Through this the onset of corrosion is delayed and the rate of corrosion reduced.

Sika® FerroGard®-903 Plus is a clear colorless liquid which does not itself normally alter the aspect of fair-faced concrete. (Check if used in conjunction with chemical cleaners).

Sika® FerroGard®-903 Plus penetrates to a depth of 25 to 40 mm in 1 month dependent on porosity of the concrete.

Sika® FerroGard®-903 Plus reaches the surface of the steel through different transport mechanisms:

- During application of Sika® FerroGard®-903 Plus transportation is mainly by Capillary suction-like water
- Sika® FerroGard®-903 Plus is later carried in solution by the penetration of water-like chlorides
- Sika® FerroGard®-903 Plus also travels by gas diffusion-like carbon dioxide

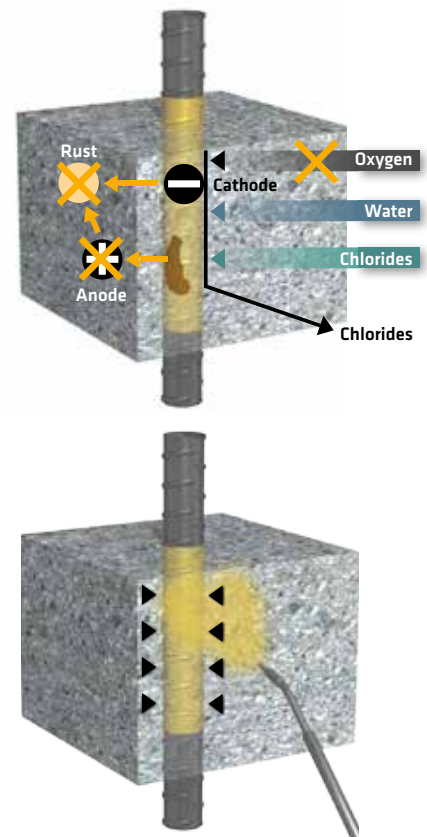

Sika® FerroGard®-903 Plus

EXAMPLES OF USES



The Sika qualitative Color Test Kit for penetration depth testing.

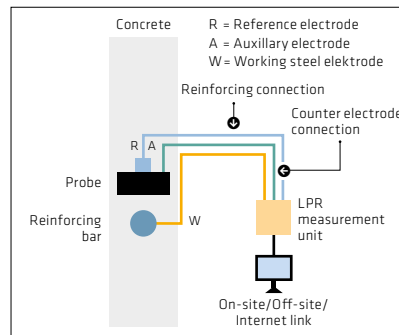

Corrosion rate maintenance monitoring system.

REINFORCED CORROSION CONTROLS OF BRIDGES

STRUCTURE/CONDITION:

- Reinforced concrete bridge structure
- Chloride induced corrosion to internal and external deck surfaces
- Localized concrete damage
- Low concrete cover to reinforcement

REQUIREMENTS:

- Reduce active corrosion rates and maintain passive corrosion levels
- Control corrosion by anodic and cathodic principles
- Provide up to 10 years additional protection before next maintenance

SIKA SOLUTION:

- Testing to prove penetration of Sika® FerroGard®-903 Plus to depth of reinforcement
- Clean concrete surfaces
- Concrete repairs using e.g. Sika MonoTop®-412 NFG
- Application of Sika® FerroGard®-903 Plus
- Application of e.g. Sikagard®-705 L Hydrophobic Impregnation

REPAIR AND PROTECTION OF BUILDING FACADES

STRUCTURE/CONDITION:

- External precast cladding panels carbonated with local concrete damage
- Chloride contaminated internal stairwells with local concrete damage
- Low cover to reinforcement. Defective waterproof joints between panels

REQUIREMENTS:

- Limit noise and dust around building
- Repair, control corrosion, enhance and protect
- Up to 15 years maintenance free period
- Maintenance monitoring system
- Re-sealing of cladding joints

SIKA SOLUTION:

- Clean concrete surfaces
- Application of Sika® FerroGard®-903 Plus
- Concrete repair with e.g. Sika MonoTop®-211 RFG
- Application of e.g. Sika MonoTop®-723 N Levelling mortar
- Application of e.g. Sikagard®-550 W Elastic protective coating
- Application of e.g. Sikaflex® AT Facade for movement joints
- Embedded probes for maintenance monitoring

REINFORCEMENT PROTECTION PRINCIPLES USING Sika® FerroGard®-903 Plus

PRINCIPLES BASED ON REMEDIATION TECHNIQUES ACCORDING TO EN 1504-9

Principles:

- Cathodic control
- Anodic control

Corrosion protection will be increased by Sika® FerroGard®-903 Plus from the beginning, even to concrete surfaces with cracks or inadequate concrete to cover over the reinforcement.

No further treatment →

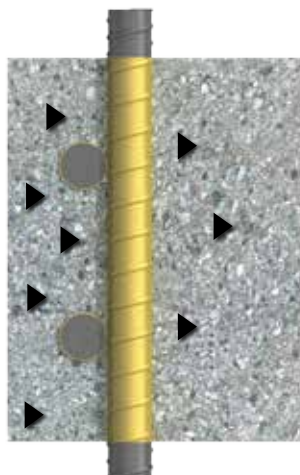

Principles:

- Cathodic control
- Anodic control
- Increased concrete resistivity

1. Application of Sika® FerroGard®-903 Plus to protect reinforcement
2. Application of a Sikagard® hydrophobic impregnation or protective coating

Sikagard® →

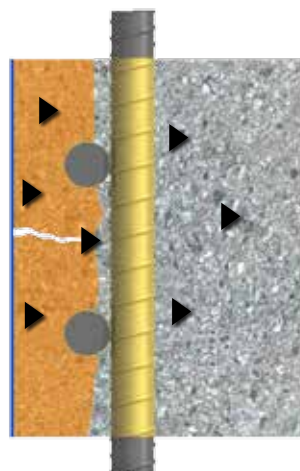

Principles:

- Concrete restoration
- Cathodic control
- Anodic control
- Increased concrete resistivity

1. Concrete repair using Sika MonoTop® system
2. Application of Sika® FerroGard®-903 Plus to protect reinforcement
3. Application of a Sikagard® hydrophobic impregnation or protective coating

Sikagard® →

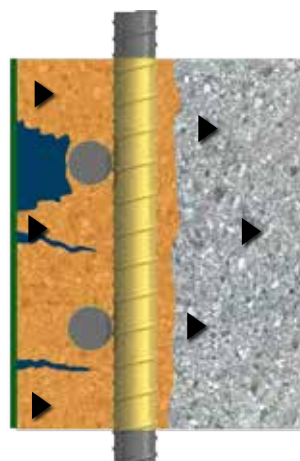

PERFORMANCE AND DURABILITY

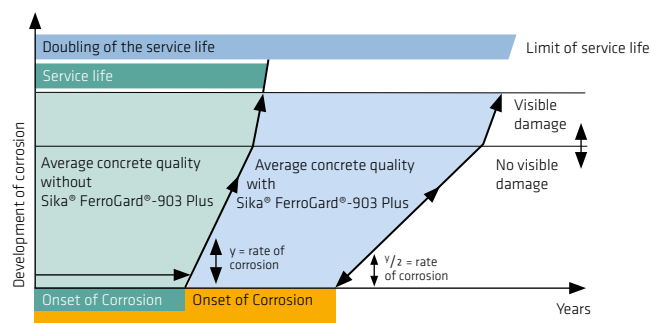

- Increased corrosion protection
- Up to double the service life of the structure compared to unprotected structure
- Concrete properties and aspects will not be changed

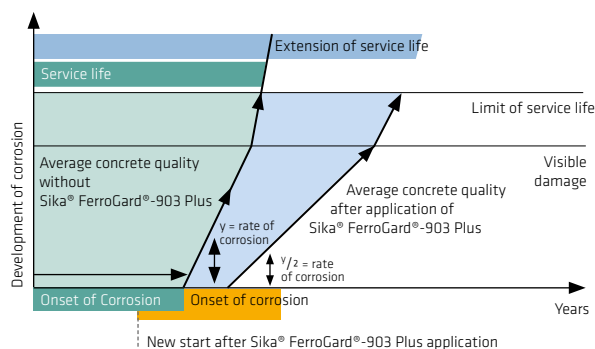

- This is the last opportunity to protect reinforcement
- Corrosion process is retarded
- Increased corrosion protection
- Protection against water/moisture ingress (coatings/hydrophobic impregnations)

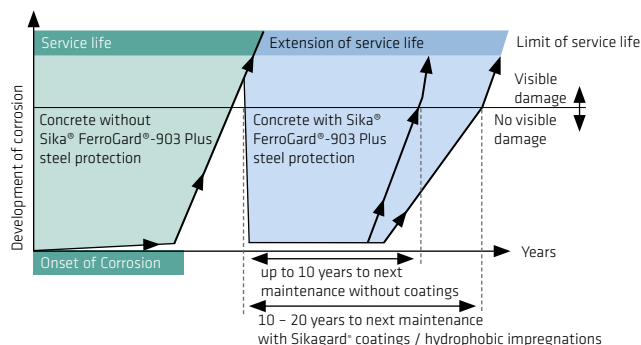

- Repair of damaged structure
- Reinstatement and protection of concrete surface
- Protection against latent damages
- Improved appearance



REPAIR AND PROTECTION – MULTI STOREY CAR PARK

STRUCTURE/CONDITION:

- Reinforced concrete decks with cracked and spalling concrete
- Corrosion of reinforcement in carbonated and chloride contaminated concrete

REQUIREMENTS:

- Reduce high and low corrosion rates by anodic, cathodic control and concrete resistivity principles
- Repair cracked and delaminated concrete and protect from future chlorides and carbonation
- Controlled concrete breakout
- Minimum 10 years to next maintenance
- Cost-effective solution

SIKA SOLUTION:

- Clean concrete surfaces
- Application of Sika® FerroGard®-903 Plus
- Concrete repairs and reprofiling with e.g. Sika MonoTop®-412 N
- Application of Protective Sika® Deck Coating System
- Application of e.g. Sikagard®-675 W carbonation protective-coating to soffits



REPAIR AND PROTECTION – CONCRETE SILOS

STRUCTURE/CONDITION:

- Cracked and spalled concrete cladding panels with low concrete cover to reinforcement
- Defective waterproof joints between panels
- Corrosion of reinforcement in carbonated and chloride contaminated concrete

REQUIREMENTS:

- Limit noise and dust
- Controlled concrete breakout
- Short repair program
- Control corrosion of steel by anodic, cathodic and concrete resistivity principles
- Up to 15 years maintenance free period
- Re-sealing of cladding joints

SIKA SOLUTION:

- Depth of penetration and permeability assessment trials to prove suitability of Sika® FerroGard®-903 Plus
- Clean concrete surfaces
- Application of Sika® FerroGard®-903 Plus
- Concrete repairs and reprofiling with e.g. Sika MonoTop®-352 N light weight mortar
- Application of e.g. Sikagard®-690 W HD long-term performance protective coating
- Application of e.g. Sikaflex® AT-Connection for construction joints

ALSO AVAILABLE FROM SIKA

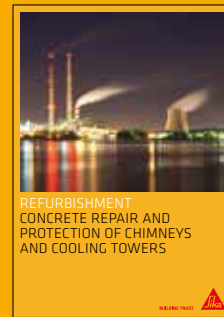

FOR MORE INFORMATION ON SIKA REFURBISHMENT SYSTEMS AND SOLUTIONS:



WE ARE SIKA

Sika is a specialty chemicals company with a leading position in the development and production of systems and products for bonding, sealing, damping, reinforcing and protecting in the building sector and the motor vehicle industry. Sika's product lines feature concrete admixtures, mortars, sealants and adhesives, structural strengthening systems, flooring as well as roofing and waterproofing systems.

Our most current General Sales Conditions shall apply. Please consult the most current local Product Data Sheet prior to any use.



SIKA SERVICES AG
Tueffenwies 16
CH-8048 Zurich
Switzerland

Contact
Phone +41 58 436 40 40
Fax +41 58 436 41 50
www.sika.com

BUILDING TRUST

